

EVALUATION KIT  
AVAILABLE

## Low-Voltage DDR Linear Regulators

### General Description

The MAX1510/MAX17510 DDR linear regulators source and sink up to 3A peak (typ) using internal n-channel MOSFETs. These linear regulators deliver an accurate 0.5V to 1.5V output from a low-voltage power input ( $V_{IN}$  = 1.1V to 3.6V). The MAX1510/MAX17510 use a separate 3.3V bias supply to power the control circuitry and drive the internal n-channel MOSFETs.

The MAX1510/MAX17510 provide current and thermal limits to prevent damage to the linear regulator. Additionally, the MAX1510/MAX17510 generate a power-good (PGOOD) signal to indicate that the output is in regulation. During startup, PGOOD remains low until the output is in regulation for 2ms (typ). The internal soft-start limits the input surge current.

The MAX1510/MAX17510 power the active-DDR termination bus that requires a tracking input reference. The MAX1510/MAX17510 can also be used in low-power chipsets and graphics processor cores that require dynamically adjustable output voltages. The MAX1510/MAX17510 are available in a 10-pin, 3mm x 3mm thin DFN package.

### Applications

Notebook/Desktop Computers  
DDR Memory Termination  
Active Termination Buses  
Graphics Processor Core Supplies  
Chipset/RAM Supplies as Low as 0.5V

### Pin Configuration

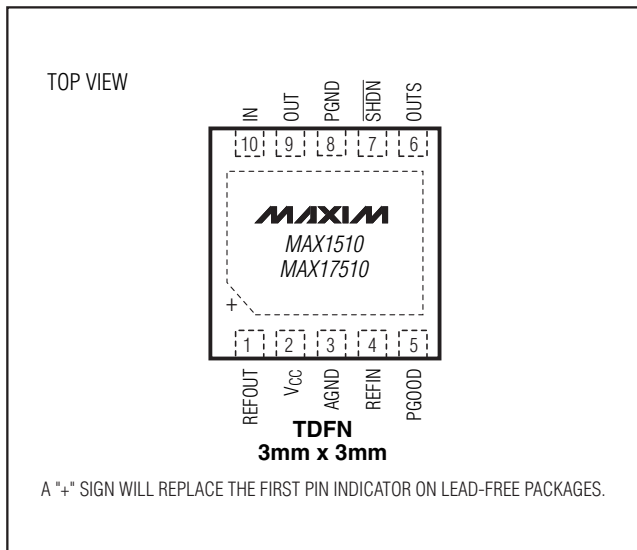

### Features

- ◆ Internal Power MOSFETs with Current Limit (3A typ)
- ◆ Fast Load-Transient Response
- ◆ External Reference Input with Reference Output Buffer
- ◆ 1.1V to 3.6V Power Input
- ◆  $\pm 15\text{mV}$  (max) Load-Regulation Error
- ◆ Thermal-Fault Protection
- ◆ Shutdown Input
- ◆ Power-Good Window Comparator with 2ms (typ) Delay
- ◆ Small, Low-Profile 10-Pin, 3mm x 3mm TDFN Package
- ◆ Ceramic or Polymer Output Capacitors

### Ordering Information

PART	TEMP RANGE	PIN-PACKAGE	TOP MARK
MAX1510ETB	-40°C to +85°C	10 TDFN-EP*	ARD
MAX1510ETB+	-40°C to +85°C	10 TDFN-EP*	ABD
MAX1510ATB/V+	-40°C to +85°C	10 TDFN-EP*	AWD
MAX17510ATB+	-40°C to +125°C	10 TDFN-EP*	AWQ
MAX17510ATB/V+	-40°C to +125°C	10 TDFN-EP*	AWQ

+Denotes a lead(Pb)-free and RoHS-compliant package.

\*EP = Exposed pad.

/V denotes an automotive qualified part.

### Typical Operating Circuit

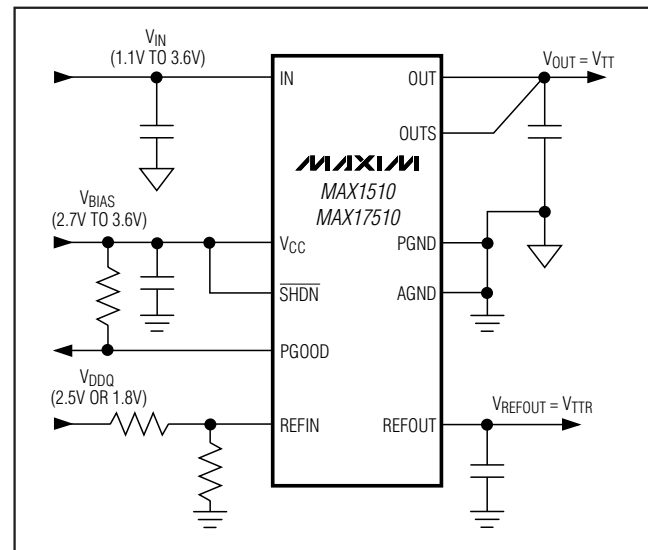

# Low-Voltage DDR Linear Regulators

## ABSOLUTE MAXIMUM RATINGS

IN to PGND	-0.3V to +4.3V
OUT to PGND	-0.3V to (V <sub>IN</sub> + 0.3V)
OUTS to AGND	-0.3V to (V <sub>IN</sub> + 0.3V)
V <sub>CC</sub> to AGND	-0.3V to +4.3V
REFIN, REFOUT, $\overline{\text{SHDN}}$ , PGOOD to AGND	-0.3V to (V <sub>CC</sub> + 0.3V)
PGND to AGND	-0.3V to +0.3V
REFOUT Short Circuit to AGND	Continuous
OUT Continuous RMS Current: 100s	±1.6A
1s	±2.5A

Continuous Power Dissipation (T <sub>A</sub> = +70°C)	
10-Pin 3mm x 3mm Thin DFN	
(derated 24.4mW/°C above +70°C)	1951mW

Stresses beyond those listed under "Absolute Maximum Ratings" may cause permanent damage to the device. These are stress ratings only, and functional operation of the device at these or any other conditions beyond those indicated in the operational sections of the specifications is not implied. Exposure to absolute maximum rating conditions for extended periods may affect device reliability.

Operating Temperature Range	
MAX1510ETB	-40°C to +85°C
MAX17510ATB	-40°C to +125°C
Junction Temperature	+150°C
Storage Temperature Range	-65°C to +150°C
Lead Temperature (soldering, 10s)	+300°C
Soldering Temperature (reflow)	
Lead(Pb)-free packages	+260°C
Packages containing lead(Pb)	+240°C

## ELECTRICAL CHARACTERISTICS

(V<sub>IN</sub> = 1.8V, V<sub>CC</sub> = 3.3V, V<sub>REFIN</sub> = V<sub>OUTS</sub> = 1.25V,  $\overline{\text{SHDN}}$  = V<sub>CC</sub>, circuit of Figure 1, T<sub>J</sub> = T<sub>A</sub> = -40°C to +85°C for MAX1510ETB, T<sub>J</sub> = T<sub>A</sub> = -40°C to +125°C for MAX17510ATB, unless otherwise noted. Typical values are at T<sub>A</sub> = +25°C.) (Note 1)

PARAMETER	SYMBOL	CONDITIONS	MIN	TYP	MAX	UNITS	
Input-Voltage Range	V <sub>IN</sub>	Power input	1.1		3.6	V	
	V <sub>CC</sub>	Bias supply	2.7		3.6		
Quiescent Supply Current (V <sub>CC</sub> )	I <sub>CC</sub>	Load = 0, V <sub>REFIN</sub> > 0.45V		0.7	1.3	mA	
Shutdown Supply Current (V <sub>CC</sub> )	I <sub>CC</sub> (SHDN)	$\overline{\text{SHDN}}$ = GND, V <sub>REFIN</sub> > 0.45V		350	600	μA	
		$\overline{\text{SHDN}}$ = GND, REFIN = GND		50	100		
Quiescent Supply Current (V <sub>IN</sub> )	I <sub>IN</sub>	Load = 0		0.4	10	mA	
Shutdown Supply Current (V <sub>IN</sub> )	I <sub>IN</sub> (SHDN)	$\overline{\text{SHDN}}$ = GND		0.1	10	μA	
Feedback-Voltage Error	V <sub>OUTS</sub>	REFIN to OUTS I <sub>OUT</sub> = ±200mA	T <sub>A</sub> = +25°C	-4	0	+4	mV
			T <sub>A</sub> = -40°C to +125°C	-6		+6	
Load-Regulation Error		-1A ≤ I <sub>OUT</sub> ≤ +1A	-15		+15	mV	
Line-Regulation Error		1.4V ≤ V <sub>IN</sub> ≤ 3.3V, I <sub>OUT</sub> = ±100mA		1		mV	
OUTS Input-Bias Current	I <sub>OUTS</sub>		-1		+1	μA	
<b>OUTPUT</b>							
Output Adjust Range			0.5		1.5	V	
OUT On-Resistance		High-side MOSFET (source) (I <sub>OUT</sub> = 0.1A)		0.14	0.25	Ω	
		Low-side MOSFET (sink) (I <sub>OUT</sub> = -0.1A)		0.14	0.25		
Output Current Slew Rate		C <sub>OUT</sub> = 100μF, I <sub>OUT</sub> = 0.1A to 2A		3		A/μs	
OUT Power-Supply Rejection Ratio	PSRR	10Hz < f < 10kHz, I <sub>OUT</sub> = 200mA, C <sub>OUT</sub> = 100μF		80		dB	
OUT-to-OUTS Resistance	R <sub>OUTS</sub>			12		kΩ	
Discharge MOSFET On-Resistance	R <sub>DISCHARGE</sub>	$\overline{\text{SHDN}}$ = GND		8		Ω	

# Low-Voltage DDR Linear Regulators

MAX1510/MAX17510

## ELECTRICAL CHARACTERISTICS (continued)

( $V_{IN} = 1.8V$ ,  $V_{CC} = 3.3V$ ,  $V_{REFIN} = V_{OUTS} = 1.25V$ ,  $\overline{SHDN} = V_{CC}$ , circuit of Figure 1,  $T_J = T_A = -40^\circ C$  to  $+85^\circ C$  for MAX1510ETB,  $T_J = T_A = -40^\circ C$  to  $+125^\circ C$  for MAX17510ATB, unless otherwise noted. Typical values are at  $T_A = +25^\circ C$ .) (Note 1)

PARAMETER	SYMBOL	CONDITIONS	MIN	TYP	MAX	UNITS
<b>REFERENCE</b>						
REFIN Voltage Range	$V_{REFIN}$		0.5		1.5	V
REFIN Input-Bias Current	$I_{REFIN}$	$T_A = +25^\circ C$	-1		+1	$\mu A$
REFIN Undervoltage-Lockout Voltage		Rising edge, hysteresis = 50mV		0.35	0.45	V
REFOUT Voltage	$V_{REFOUT}$	$V_{CC} = 3.3V$ , $I_{REFOUT} = 0V$	$V_{REFIN} - 0.01$	$V_{REFIN}$	$V_{REFIN} + 0.01$	V
REFOUT Load Regulation	$\Delta V_{REFOUT}$	$I_{REFOUT} = \pm 5mA$	-20		+20	mV
<b>FAULT DETECTION</b>						
Thermal-Shutdown Threshold	$T_{SHDN}$	Rising edge, hysteresis = 15 $^\circ C$		+165		$^\circ C$
$V_{CC}$ Undervoltage-Lockout Threshold	$V_{UVLO}$	Rising edge, hysteresis = 100mV	2.45	2.55	2.65	V
IN Undervoltage-Lockout Threshold		Rising edge, hysteresis = 55mV		0.9	1.1	V
Current-Limit Threshold	$I_{LIMIT}$	$T_A = -40^\circ C$ to $+85^\circ C$	1.8	3	4.2	A
		$T_A = -40^\circ C$ to $+125^\circ C$	1.5	3	4.2	
Soft-Start Current-Limit Time	$t_{SS}$			200		$\mu s$
<b>INPUTS AND OUTPUTS</b>						
PGOOD Lower Trip Threshold		With respect to feedback threshold, hysteresis = 12mV	-200	-150	-100	mV
PGOOD Upper Trip Threshold		With respect to feedback threshold, hysteresis = 12mV	100	150	200	mV
PGOOD Propagation Delay	$t_{PGOOD}$	OUTS forced 25mV beyond PGOOD trip threshold	5	10	35	$\mu s$
PGOOD Startup Delay		Startup rising edge, OUTS within $\pm 100mV$ of the feedback threshold	1	2	3.5	ms
PGOOD Output Low Voltage		$I_{SINK} = 4mA$			0.3	V
PGOOD Leakage Current	$I_{PGOOD}$	OUTS = REFIN (PGOOD high impedance), PGOOD = $V_{CC} + 0.3V$ , $T_A = +25^\circ C$			1	$\mu A$
$\overline{SHDN}$ Logic Input Threshold		Logic-high			2.0	V
		Logic-low	0.8			V
$\overline{SHDN}$ Logic Input Current		$\overline{SHDN} = V_{CC}$ or GND, $T_A = +25^\circ C$	-1		+1	$\mu A$

**Note 1:** Limits are 100% production tested at  $T_A = +25^\circ C$ . Limits over the operating temperature range are guaranteed through correlation using statistical-quality-control (SQC) methods.

# Low-Voltage DDR Linear Regulators

## Typical Operating Characteristics

(Circuit of Figure 1.  $T_A = +25^\circ\text{C}$ , unless otherwise noted.)

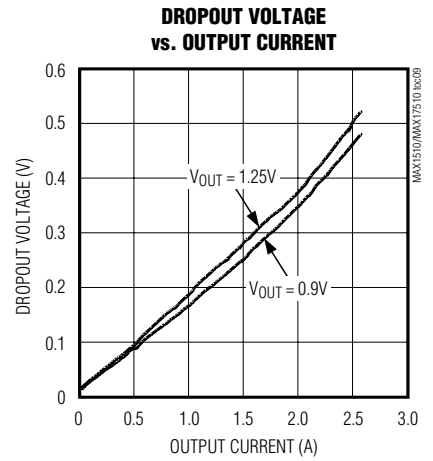
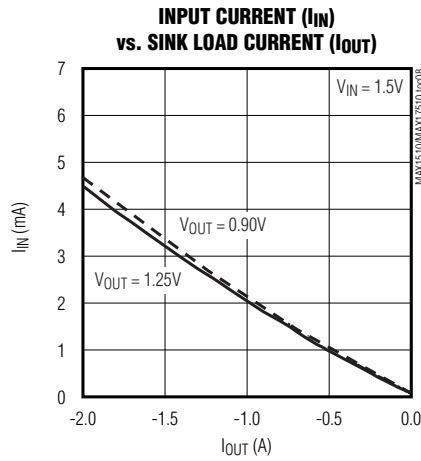
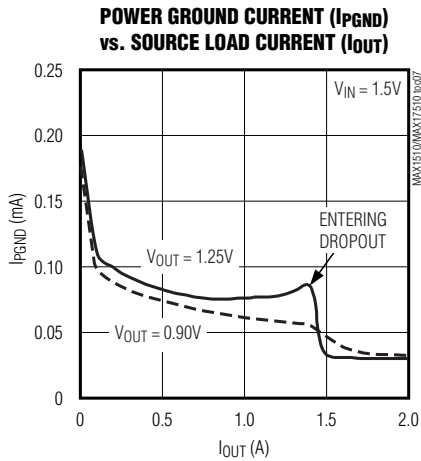
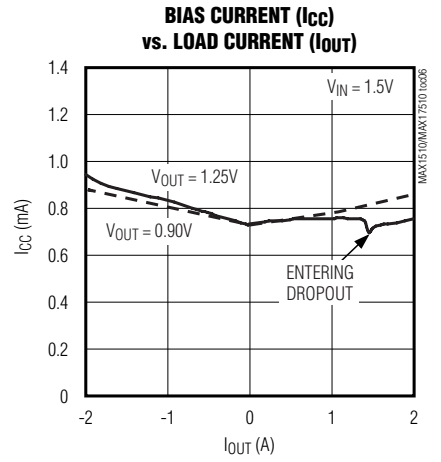
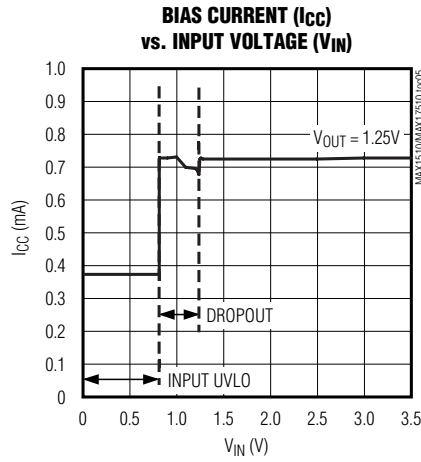
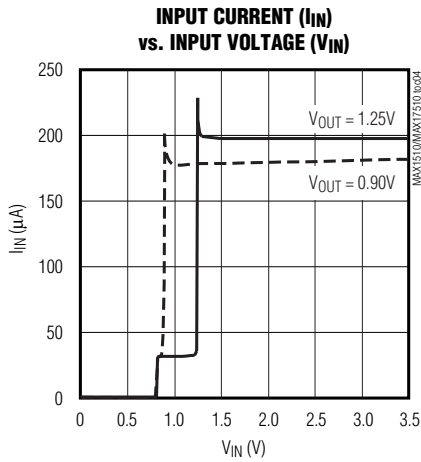
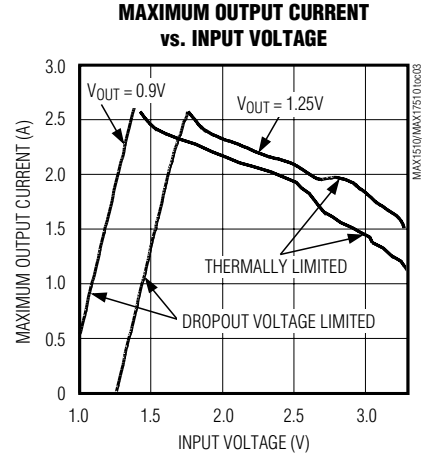
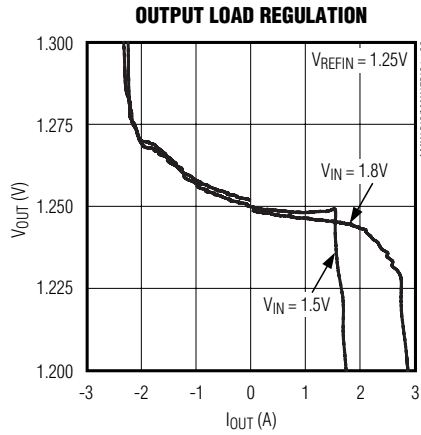
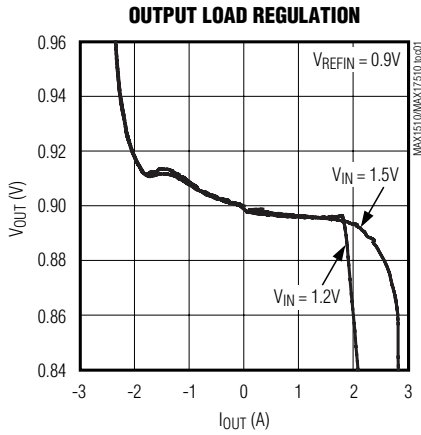

# Low-Voltage DDR Linear Regulators

## Typical Operating Characteristics (continued)

(Circuit of Figure 1.  $T_A = +25^\circ\text{C}$ , unless otherwise noted.)

MAX1510/MAX17510

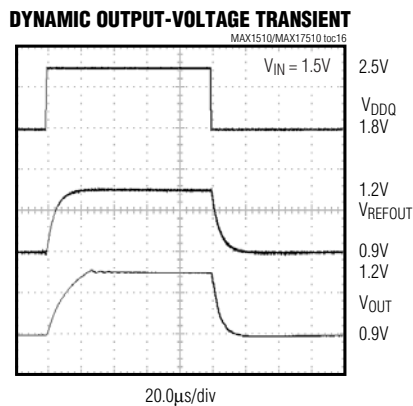
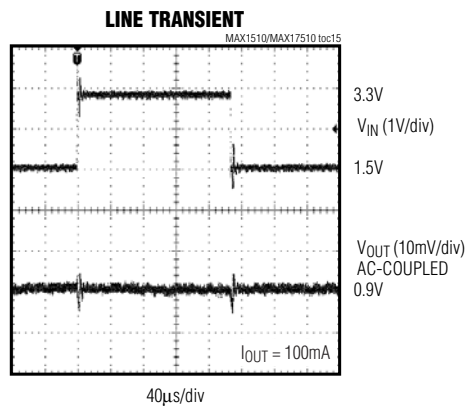
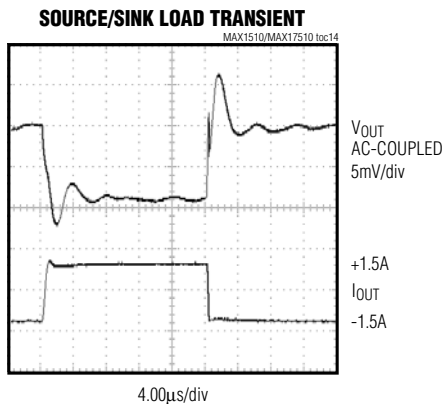
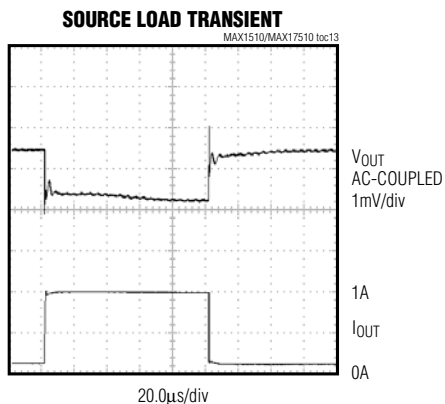
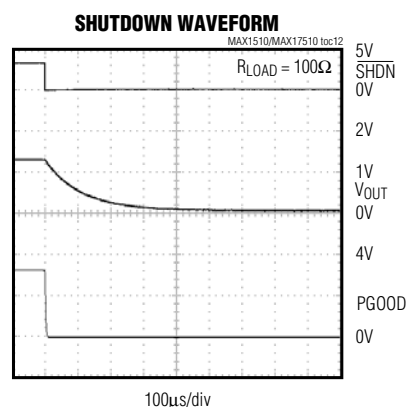
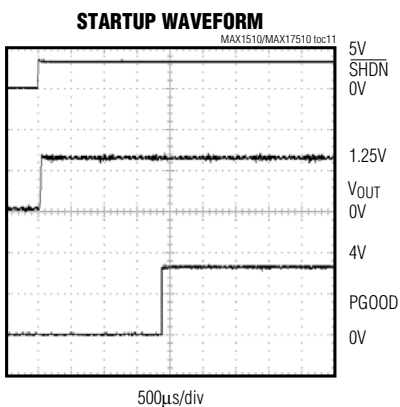
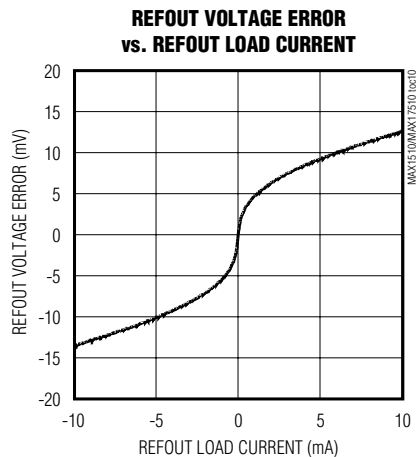

# Low-Voltage DDR Linear Regulators

## Typical Operating Characteristics (continued)

(Circuit of Figure 1.  $T_A = +25^\circ\text{C}$ , unless otherwise noted.)

**DYNAMIC OUTPUT-VOLTAGE TRANSIENT**

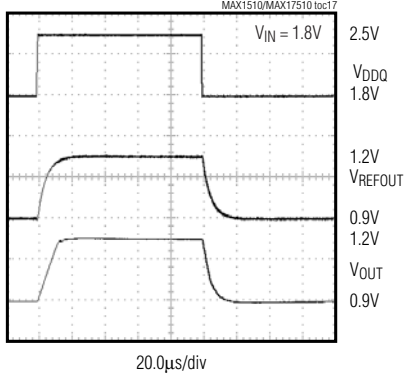

**SINK CURRENT-LIMIT DISTRIBUTION**

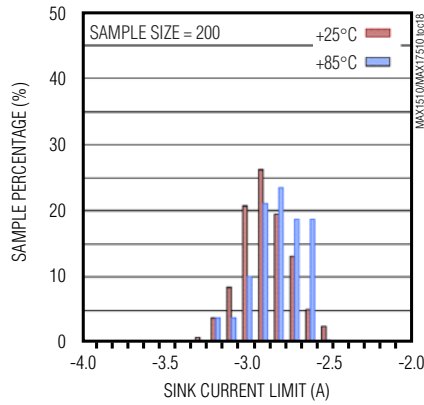

**SOURCE CURRENT-LIMIT DISTRIBUTION**

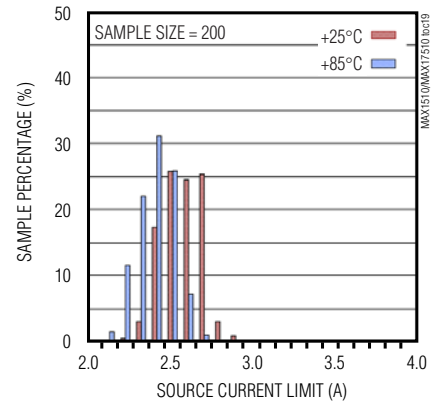

**SINK CURRENT-LIMIT DISTRIBUTION**  
 $T_A = +125^\circ\text{C}$

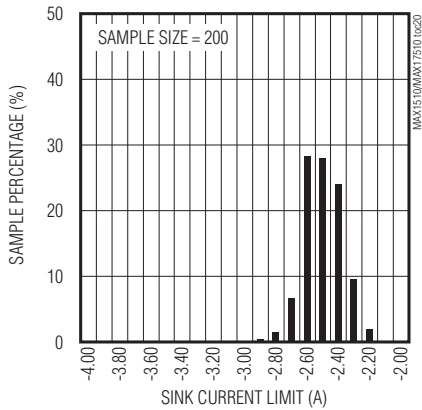

**SOURCE CURRENT-LIMIT DISTRIBUTION**  
 $T_A = +125^\circ\text{C}$

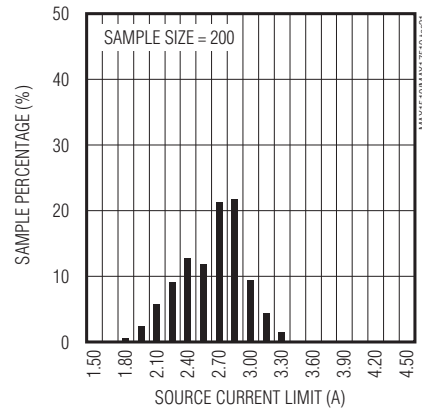

**SINK LOAD REGULATION DISTRIBUTION**  
 $I_{OUT} = -1\text{A}, T_A = +125^\circ\text{C}$

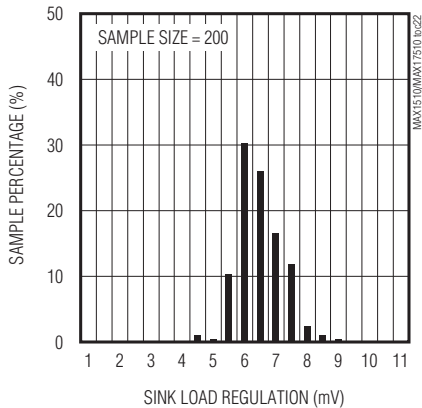

**SINK CURRENT-LIMIT DISTRIBUTION**  
 $T_A = +125^\circ\text{C}$

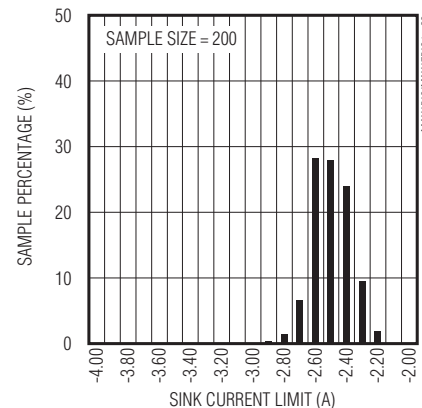

# Low-Voltage DDR Linear Regulators

## Pin Description

MAX1510/MAX17510

PIN	NAME	FUNCTION
1	REFOUT	Buffered Reference Output. The output of the unity-gain reference input buffer sources and sinks over 5mA. Bypass REFOUT to AGND with a 0.33 $\mu$ F or greater ceramic capacitor.
2	V <sub>CC</sub>	Analog Supply Input. Connect to the system supply voltage (+3.3V). Bypass V <sub>CC</sub> to AGND with a 1 $\mu$ F or greater ceramic capacitor.
3	AGND	Analog Ground. Connect the backside pad to AGND.
4	REFIN	External Reference Input. REFIN sets the output regulation voltage ( $V_{OUTS} = V_{REFIN}$ ).
5	PGOOD	Open-Drain Power-Good Output. PGOOD is low when the output voltage is more than 150mV (typ) above or below the regulation point, during soft-start, and when shut down. 2ms after the output reaches the regulation voltage during startup, PGOOD becomes high impedance.
6	OUTS	Output Sense Input. The OUTS regulation level is set by the voltage at REFIN. Connect OUTS to the remote DDR termination bypass capacitors. OUTS is internally connected to OUT through a 12k $\Omega$ resistor.
7	$\overline{\text{SHDN}}$	Shutdown Control Input. Connect to V <sub>CC</sub> for normal operation. Connect to analog ground to shut down the linear regulator. The reference buffer remains active in shutdown.
8	PGND	Power Ground. Internally connected to the output sink MOSFET.
9	OUT	Output of the Linear Regulator
10	IN	Power Input. Internally connected to the output source MOSFET.
—	EP	Exposed Pad. Internally connected to AGND. Connect EP to AGND PCB ground plane to maximize thermal performance. Not intended as an electrical connection point.

## Detailed Description

The MAX1510/MAX17510 are low-voltage, low-dropout DDR termination linear regulators with an external bias supply input and a buffered reference output (see Figures 1 and 2). V<sub>CC</sub> is powered by a 2.7V to 3.6V supply that is commonly available in laptop and desktop computers. The 3.3V bias supply drives the gate of the internal pass transistor, while a lower voltage input at the drain of the transistor (IN) is regulated to provide V<sub>OUT</sub>. By using separate bias and power inputs, the MAX1510/MAX17510 can drive an n-channel high-side MOSFET and use a lower input voltage to provide better efficiency.

The MAX1510/MAX17510 regulate their output voltage to the voltage at REFIN. When used in DDR applications as a termination supply, the MAX1510/MAX17510 deliver 1.25V or 0.9V at 3A peak (typ) from an input voltage of 1.1V to 3.6V. The MAX1510/MAX17510 sink up to 3A peak (typ) as required in a termination supply. The MAX1510/MAX17510 provide shoot-through protection, ensuring that the source and sink MOSFETs do not conduct at the same time, yet produce a fast source-to-sink load transient.

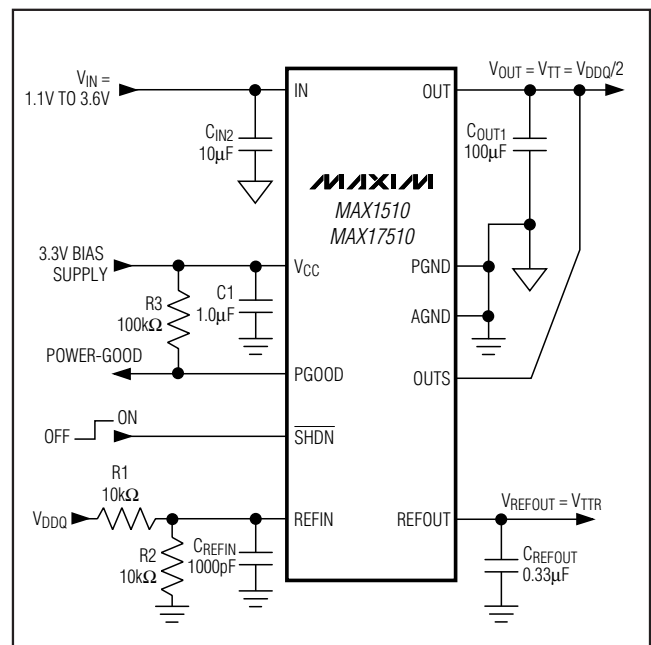

Figure 1. Standard Application Circuit

# Low-Voltage DDR Linear Regulators

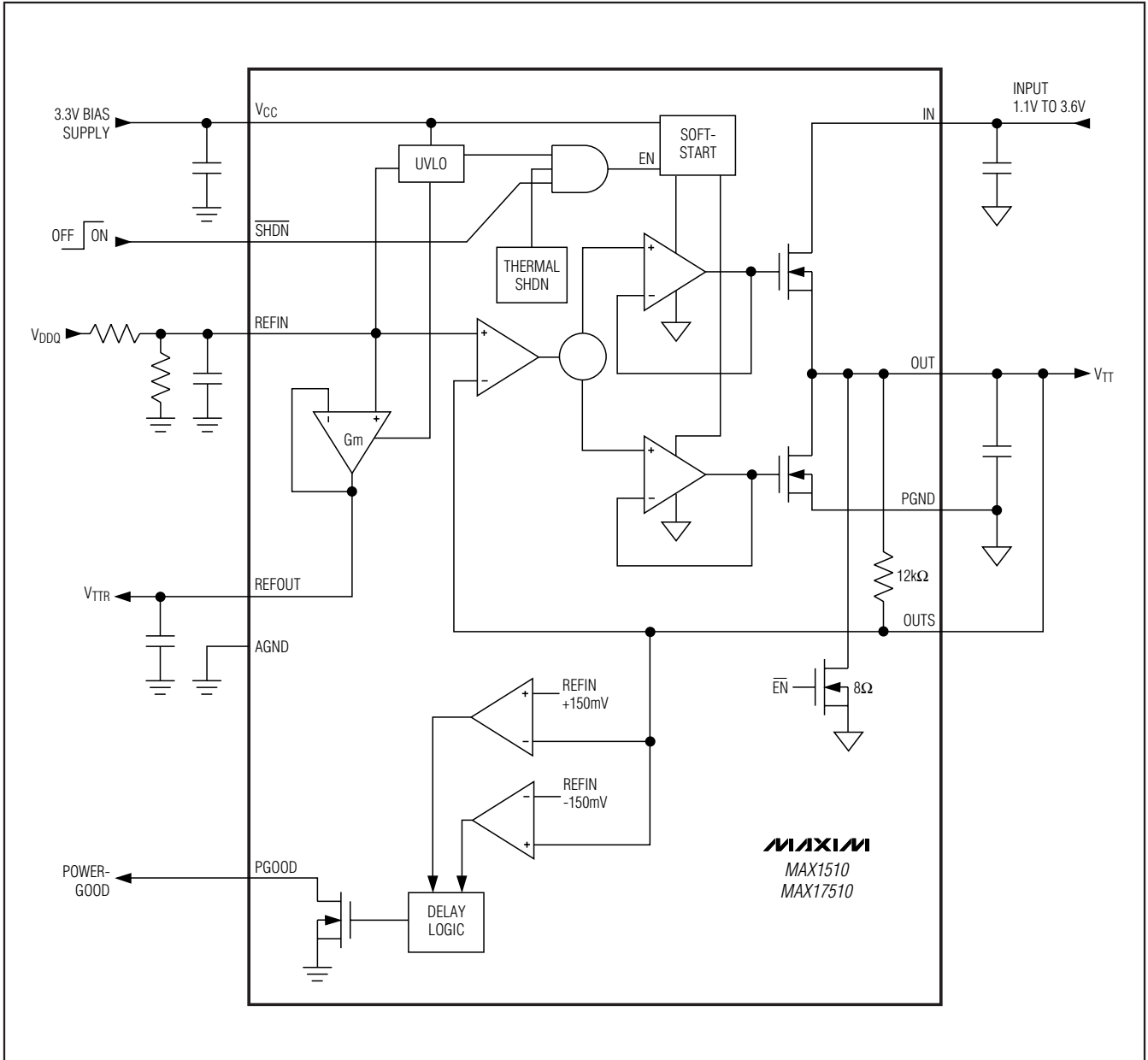

Figure 2. Functional Diagram



## Low-Voltage DDR Linear Regulators

The MAX1510/MAX17510 feature an open-drain PGOOD output that transitions high 2ms after the output initially reaches regulation. PGOOD goes low within 10 $\mu$ s of when the output goes out of regulation by  $\pm$ 150mV. The MAX1510/MAX17510 feature current- and thermal-limiting circuitry to prevent damage during fault conditions.

### 3.3V Bias Supply (V<sub>CC</sub>)

The V<sub>CC</sub> input powers the control circuitry and provides the gate drive to the pass transistor. This improves efficiency by allowing V<sub>IN</sub> to be powered from a lower supply voltage. Power V<sub>CC</sub> from a well-regulated 3.3V supply. Current drawn from the V<sub>CC</sub> supply remains relatively constant with variations in V<sub>IN</sub> and load current. Bypass V<sub>CC</sub> with a 1 $\mu$ F or greater ceramic capacitor as close to the device as possible.

### V<sub>CC</sub> Undervoltage Lockout (UVLO)

The V<sub>CC</sub> input undervoltage-lockout (UVLO) circuitry ensures that the regulator starts up with adequate voltage for the gate-drive circuitry to bias the internal pass transistor. The UVLO threshold is 2.55V (typ). V<sub>CC</sub> must remain above this level for proper operation.

### Power-Supply Input (I<sub>N</sub>)

I<sub>N</sub> provides the source current for the linear regulator's output, OUT. I<sub>N</sub> connects to the drain of the internal n-channel power MOSFET. I<sub>N</sub> can be as low as 1.1V, minimizing power dissipation. The input UVLO prohibits operation below 0.8V (typ). Bypass I<sub>N</sub> with a 10 $\mu$ F or greater capacitor as close to the device as possible.

### Reference Input (REFIN)

The MAX1510/MAX17510 regulate OUTS to the voltage set at REFIN, making the MAX1510/MAX17510 ideal for memory applications where the termination supply must track the supply voltage. Typically, REFIN is set by an external resistive voltage-divider connected to the memory supply (V<sub>DDQ</sub>) as shown in Figure 1.

The maximum output voltage of 1.5V is limited by the gate-drive voltage of the internal n-channel power transistor.

### Buffered Reference Output (REFOUT)

REFOUT is a unity-gain transconductance amplifier that generates the DDR reference supply. It sources and sinks greater than 5mA. The reference buffer is typically

connected to ceramic bypass capacitors (0.33 $\mu$ F to 1.0 $\mu$ F). REFOUT is active when V<sub>REFIN</sub> > 0.45V and V<sub>CC</sub> is above V<sub>UVLO</sub>. REFOUT is independent of  $\overline{\text{SHDN}}$ .

### Shutdown

Drive  $\overline{\text{SHDN}}$  low to disable the error amplifier, gate-drive circuitry, and pass transistor (Figure 2). In shutdown, OUT is terminated to GND with an 8 $\Omega$  MOSFET. REFOUT is independent of  $\overline{\text{SHDN}}$ . Connect  $\overline{\text{SHDN}}$  to V<sub>CC</sub> for normal operation.

### Current Limit

The MAX1510/MAX17510 feature source and sink current limits to protect the internal n-channel MOSFETs. The source and sink MOSFETs have a typical 3A current limit (1.8A min). This current limit prevents damage to the internal power transistors, but the device can enter thermal shutdown if the power dissipation increases the die temperature above +165 $^{\circ}$ C (see the *Thermal-Overload Protection* section).

### Soft-Start Current Limit

Soft-start gradually increases the internal source current limit to reduce input surge currents at startup. Full-source current limit is available after the 200 $\mu$ s soft-start timer has expired. The soft-start current limit is given by:

$$I_{\text{LIMIT(SS)}} = \frac{I_{\text{LIMIT}} \times t}{t_{\text{SS}}}$$

where I<sub>LIMIT</sub> and t<sub>SS</sub> are from the *Electrical Characteristics*.

### Thermal-Overload Protection

Thermal-overload protection prevents the linear regulator from overheating. When the junction temperature exceeds +165 $^{\circ}$ C, the linear regulator and reference buffer are disabled, allowing the device to cool. Normal operation resumes once the junction temperature cools by 15 $^{\circ}$ C. Continuous short-circuit conditions result in a pulsed output until the overload is removed. A continuous thermal-overload condition results in a pulsed output. For continuous operation, do not exceed the absolute maximum junction-temperature rating of +150 $^{\circ}$ C.

# Low-Voltage DDR Linear Regulators

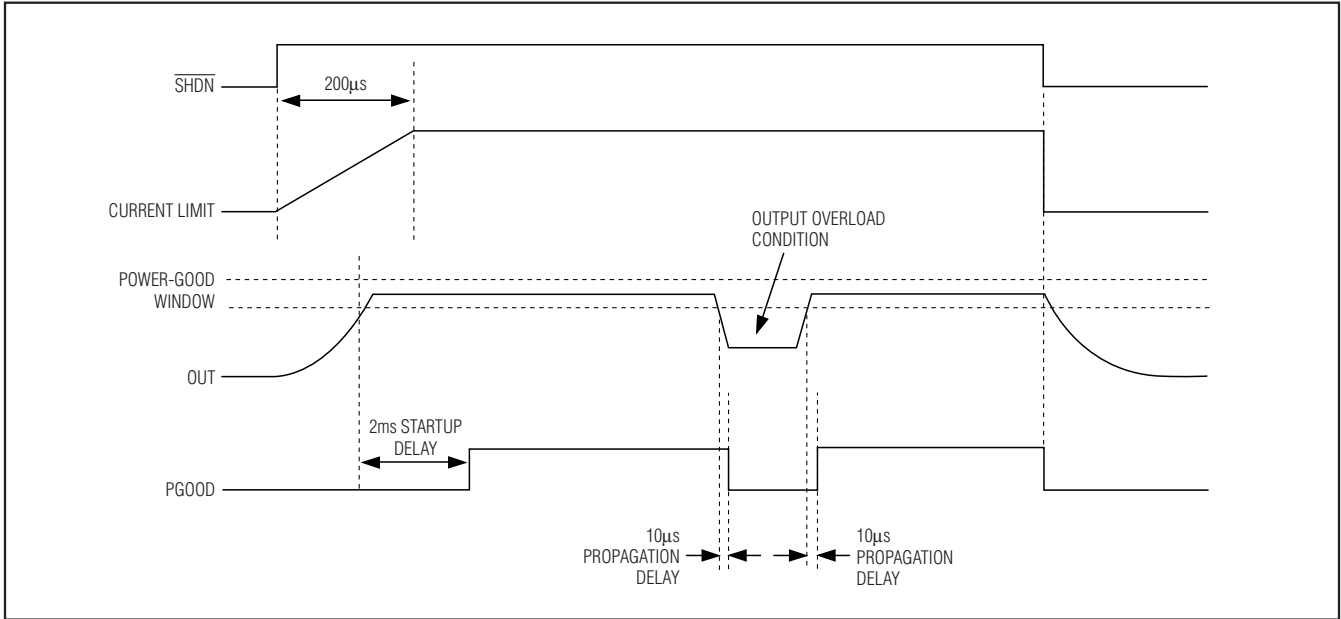

Figure 3. MAX1510/MAX17510 PGOOD and Soft-Start Waveforms

### Power-Good (PGOOD)

The MAX1510/MAX17510 provide an open-drain PGOOD output that goes high 2ms (typ) after the output initially reaches regulation during startup as shown in Figure 3. PGOOD transitions low 10µs after the output goes out of regulation by ±150mV, or when the device enters shutdown. Connect a pullup resistor from PGOOD to VCC for a logic-level output. Use a 100kΩ resistor to minimize current consumption.

### Applications Information

#### Dynamic Output-Voltage Transitions

By changing the voltage at REFIN, the MAX1510/MAX17510 can be used in applications that require dynamic output-voltage changes between two set points (graphics processors). Figure 4 shows a dynamically adjustable resistive voltage-divider network at REFIN. Using an external signal MOSFET, a resistor can be switched in and out of the REFIN resistor-divider, changing the voltage at REFIN. The two output voltages are determined by the following equations:

$$V_{OUT(Low)} = V_{REF} \left( \frac{R_2}{R_1 + R_2} \right)$$

$$V_{OUT(High)} = V_{REF} \left[ \frac{(R_2 + R_3)}{R_1 + (R_2 + R_3)} \right]$$

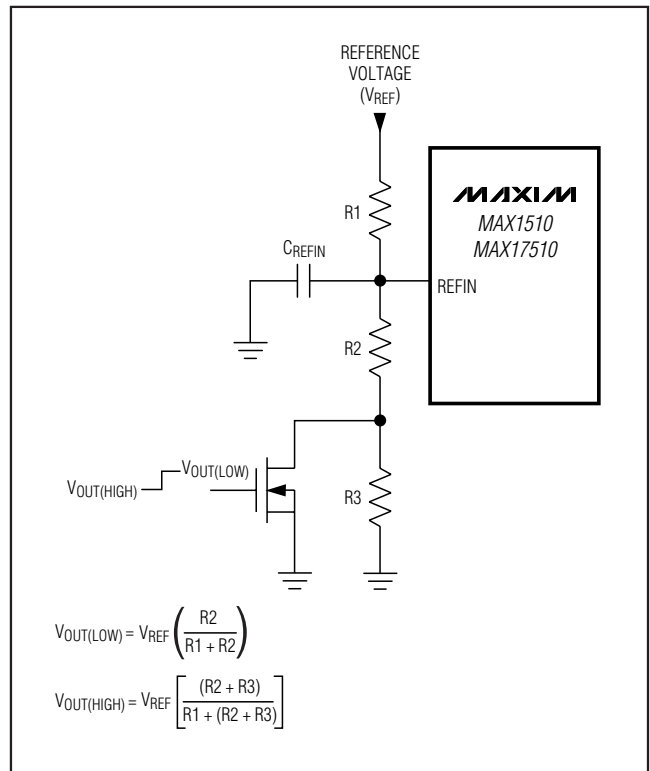

Figure 4. Dynamic Output-Voltage Change

# Low-Voltage DDR Linear Regulators

For a step voltage change at REFIN, the rate of change of the output voltage is limited by the total output capacitance, the current limit, and the load during the transition. Adding a capacitor across REFIN and AGND filters noise and controls the rate of change of the REFIN voltage during dynamic transitions. With the additional capacitance, the REFIN voltage slews between the two set points with a time constant given by  $RE_{EQ} \times C_{REFIN}$ , where  $RE_{EQ}$  is the equivalent parallel resistance seen by the slew capacitor.

## Operating Region and Power Dissipation

The maximum power dissipation of the MAX1510/MAX17510 depends on the thermal resistance of the 10-pin TDFN package and the circuit board, the temperature difference between the die and ambient air, and the rate of airflow. The power dissipated in the device is:

$$P_{SRC} = I_{SRC} \times (V_{IN} - V_{OUT})$$

$$P_{SINK} = I_{SINK} \times V_{OUT}$$

The resulting maximum power dissipation is:

$$P_{DIS(MAX)} = \frac{T_{J(MAX)} - T_A}{\theta_{JC} + \theta_{CA}}$$

where  $T_{J(MAX)}$  is the maximum junction temperature (+150°C),  $T_A$  is the ambient temperature,  $\theta_{JC}$  is the thermal resistance from the die junction to the package case, and  $\theta_{CA}$  is the thermal resistance from the case through the PCB, copper traces, and other materials to the surrounding air. For optimum power dissipation, use a large ground plane with good thermal contact to the backside pad, and use wide input and output traces.

When 1 square inch of copper is connected to the device, the maximum allowable power dissipation of a 10-pin DFN package is 1951mW. The maximum power dissipation is derated by 24.4mW/°C above  $T_A = +70^\circ\text{C}$ . Extra copper on the PCB increases thermal mass and reduces thermal resistance of the board. Refer to the MAX1510 evaluation kit for a layout example.

The MAX1510/MAX17510 deliver up to 3A and operate with input voltages up to 3.6V, but not simultaneously. High output currents can only be achieved when the input-output differential voltages are low (Figure 5).

## Dropout Operation

A regulator's minimum input-to-output voltage differential (dropout voltage) determines the lowest usable supply voltage. Because the MAX1510/MAX17510 use an n-channel pass transistor, the dropout voltage is a function of the drain-to-source on-resistance ( $R_{DS(ON)}$  = 0.25Ω max) multiplied by the load current (see the *Typical Operating Characteristics*):

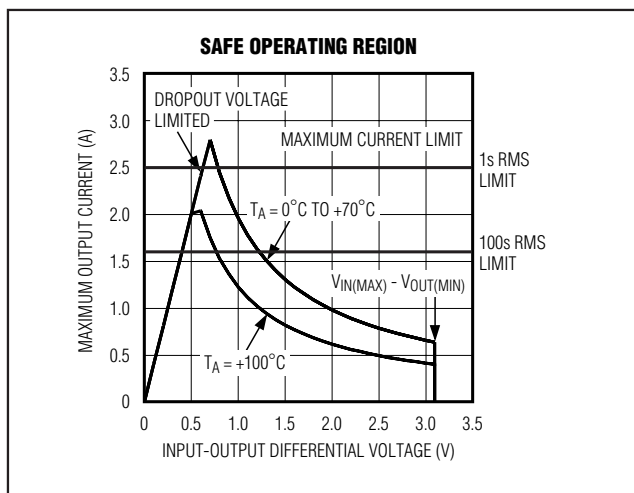

Figure 5. Power Operating Region—Maximum Output Current vs. Input-Output Differential Voltage

$$V_{DROPOUT} = R_{DS(ON)} \times I_{OUT}$$

For low output-voltage applications, the sink current is limited by the output voltage and the  $R_{DS(ON)}$  of the MOSFET.

## Input Capacitor Selection

Bypass IN to PGND with a 10μF or greater ceramic capacitor. Bypass VCC to AGND with a 1μF ceramic capacitor for normal operation in most applications. Typically, the LDO is powered from the output of a step-down controller (memory supply) that has additional bulk capacitance (polymer or tantalum) and distributed ceramic capacitors.

## Output Capacitor Selection

The MAX1510/MAX17510 output stability is independent of the output capacitance for  $C_{OUT}$  from 10μF to 220μF. Capacitor ESR between 2mΩ and 50mΩ is needed to maintain stability. Within the recommended capacitance and ESR limits, the output capacitor should be chosen to provide good transient response:

$$\Delta I_{OUT(P-P)} \times ESR = \Delta V_{OUT(P-P)}$$

where  $\Delta I_{OUT(P-P)}$  is the maximum peak-to-peak load-current step (typically equal to the maximum source load plus the maximum sink load), and  $\Delta V_{OUT(P-P)}$  is the allowable peak-to-peak voltage tolerance.

Using larger output capacitance can improve efficiency in applications where the source and sink currents change rapidly. The capacitor acts as a reservoir for the rapid source and sink currents, so no extra current is supplied by the MAX1510/MAX17510 or discharged to ground, improving efficiency.

## Low-Voltage DDR Linear Regulators

### Noise, PSRR, and Transient Response

The MAX1510/MAX17510 operate with low-dropout voltage and low quiescent current in notebook computers while maintaining good noise, transient response, and AC rejection specifications. Improved supply-noise rejection and transient response can be achieved by increasing the values of the input and output capacitors. Use passive filtering techniques when operating from noisy sources.

The MAX1510/MAX17510 load-transient response graphs (see the *Typical Operating Characteristics*) show two components of the output response: a DC shift from the output impedance due to the load-current change and the transient response. A typical transient response for a step change in the load current from -1.5A to +1.5A is 10mV. Increasing the output capacitor's value and decreasing the ESR attenuate the overshoot.

### PCB Layout Guidelines

The MAX1510/MAX17510 require proper layout to achieve the intended output power level and low noise. Proper layout involves the use of a ground plane, appropriate component placement, and correct routing of traces using appropriate trace widths. Refer to the MAX1510 evaluation kit for a layout example:

- Minimize high-current ground loops. Connect the ground of the device, the input capacitor, and the output capacitor together at one point.
- To optimize performance, a ground plane is essential. Use all available copper layers in applications where the device is located on a multilayer board.
- Connect the input filter capacitor less than 10mm from IN. The connecting copper trace carries large currents and must be at least 2mm wide, preferably 5mm wide.
- Connect the backside pad to a large ground plane. Use as much copper as necessary to decrease the thermal resistance of the device. In general, more copper provides better heatsinking capabilities.

---

### Chip Information

PROCESS: BiCMOS

---

### Package Information

For the latest package outline information and land patterns (footprints), go to [www.maxim-ic.com/packages](http://www.maxim-ic.com/packages). Note that a "+", "#", or "-" in the package code indicates RoHS status only. Package drawings may show a different suffix character, but the drawing pertains to the package regardless of RoHS status.

PACKAGE TYPE	PACKAGE CODE	OUTLINE NO.	LAND PATTERN NO.
10 TDFN	T1033+1	<a href="#">21-0137</a>	<a href="#">90-0003</a>

# Low-Voltage DDR Linear Regulators

## Revision History

REVISION NUMBER	REVISION DATE	DESCRIPTION	PAGES CHANGED
0	5/04	Initial release	—
1	1/05	Raised Absolute Maximum rating	1, 14
2	8/05	Added MAX1510ETB	1
3	4/09	Added automotive-qualified part MAX1510ETB/V+	1, 2, 7, 12, 13
4	7/09	Added MAX17510 to data sheet; added temperature grades for MAX1510ATB+ and MAX1510ATB/V+; minor edits	1, 2, 3, 6, 7, 12, 13
5	3/11	Added MAX17510 automotive qualified part	1

MAX1510/MAX17510

Maxim cannot assume responsibility for use of any circuitry other than circuitry entirely embodied in a Maxim product. No circuit patent licenses are implied. Maxim reserves the right to change the circuitry and specifications without notice at any time.

Maxim Integrated Products, 120 San Gabriel Drive, Sunnyvale, CA 94086 408-737-7600 \_\_\_\_\_ 13